

EN

English, 1

IDP 148

Contents

Installation, 2-3-4

Positioning and levelling
Connecting the water and electricity supplies
Advice regarding the first wash cycle
Technical data
Electrical connection

Description of the appliance, 5

Overall view
Control panel

Loading the racks, 6

Lower rack
Cutlery basket
Upper rack

Start-up and use, 7-8

Starting the dishwasher
Measuring out the detergent
Wash options

Wash cycles, 9

Table of wash cycles

Rinse aid and refined salt, 10

Measuring out the rinse aid
Measuring out the refined salt

Care and maintenance, 11

Shutting off the water and electricity supplies
Cleaning the dishwasher
Preventing unpleasant odours
Cleaning the sprayer arms
Cleaning the water inlet filter
Cleaning the filters
Leaving the machine unused for extended periods

Precautions and advice, 12

General safety
Disposal
Saving energy and respecting the environment

Troubleshooting, 13

Guarantee, 14

After Sales Service, 15

Installation

EN

⚠ Keep this instruction manual in a safe place for future reference. If the appliance is sold, given away or moved, please ensure the manual is kept with the machine, so that the new owner may benefit from the advice contained within it.

⚠ Please read this instruction manual carefully: it contains important information regarding the safe installation, use and maintenance of the appliance.

⚠ If the appliance must be moved at any time, keep it in an upright position; if absolutely necessary, it may be tilted onto its back.

⚠ This appliance is intended to be used in household and similar applications such as:

- staff kitchen areas in shops, offices and other working environments;
- farm houses;
- by clients in hotels, motels and other residential type environments;
- bed and breakfast type environments.

Positioning and levelling

1. Remove the appliance from all packaging and check that it has not been damaged during transportation. If it has been damaged, contact the retailer and do not proceed any further with the installation process.

2. Check the dishwasher by placing it so that its sides or back panel are in contact with the adjacent cabinets or even with the wall. This appliance can also be recessed under a single worktop* (see the *Assembly instruction sheet*).

3. Position the dishwasher on a level and sturdy floor. If the floor is uneven, the front feet of the appliance may be adjusted until it reaches a horizontal position. If the appliance is levelled correctly, it will be more stable and much less likely to move or cause vibrations and noise while it is operating.

4. Adjust the height of the rear foot from the front of the appliance* on the central lower part of the dishwasher, turning a hexagonal spanner (red color) with an opening of 8 mm in a clockwise direction to increase the height or in an anticlockwise direction to decrease the height.

Connecting the water and electricity supplies

⚠ Connection to the water and electricity supplies should only be performed by a qualified technician.

⚠ The dishwasher should not stand on top of the water hoses or the electricity supply cable.

⚠ The appliance must be connected to the water supply network using new hoses. Do not use old hoses.

The water inlet and outlet hoses and the electricity supply cable may be positioned towards the right or the left in order to achieve the best possible installation.

Connecting the water inlet hose

- To a suitable cold water connection point: before attaching the hose, run the water until it is perfectly clear so that any impurities that may be present in the water do not clog the appliance; after performing this operation, screw the inlet hose tightly onto a tap with a $\frac{3}{4}$ gas threaded connection.
- To a suitable hot water connection point: your dishwasher may be supplied with hot water from the mains supply (if you have a central heating system with radiators) provided that it does not exceed a temperature of 60°C. Screw the hose to the tap as described for connection to a cold water supply.

⚠ If the inlet hose is not long enough, contact a specialist store or an authorised technician (see *Assistance*).

⚠ The water pressure must be within the values indicated in the Technical data table (see *adjacent information*).

⚠ The hose should not be bent or compressed.

Connecting the water outlet hose

Connect the outlet hose (without bending it) to a drain duct with a minimum diameter of 4 cm.

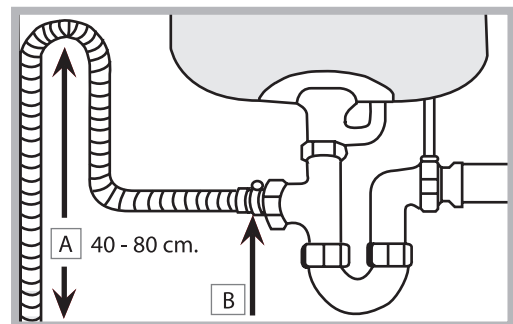

The outlet hose must be at a height ranging from 40 to 80 cm from the floor / surface where the dishwasher rests (A).

Before connecting the water outlet hose to the sink drain, remove the plastic plug (B).

* Only available in selected models.

Anti-flooding protection

To ensure floods do not occur, the dishwasher:
- is provided with a special system which blocks the water supply in the event of anomalies or leaks from inside the appliance.

Some models are also equipped with the supplementary safety device *New Acqua Stop**, which guarantees anti-flooding protection even in the event of a supply hose rupture.



WARNING: HAZARDOUS VOLTAGE!

Under no circumstance should the water inlet hose be cut as it contains live electrical parts.

Electrical connection

Before inserting the plug into the electrical socket, make sure that:

- The socket is earthed and complies with current regulations.
- The socket can withstand the maximum load of the appliance, which is indicated on the data plate located on the inside of the door (*see chapter entitled Description of the appliance*).
- The power supply voltage falls within the values indicated on the data plate on the inside of the door.
- The socket is compatible with the plug of the appliance. If this is not the case, ask an authorised technician to replace the plug (*see Assistance*); do not use extension cables or multiple sockets.

 Once the appliance has been installed, the power supply cable and the electrical socket should be easily accessible.

 The cable should not be bent or compressed.

 If the power supply cable is damaged, it must be replaced by the manufacturer or its Technical Assistance Service in order to prevent all potential hazards. (See Assistance)

 The Company shall not be held responsible for any incidents that occur if these regulations are not observed.



Anti-condensation strip*

After installing the dishwasher, open the door and stick the adhesive transparent strip under the wooden shelf in order to protect it from any condensation which may form.

Advice regarding the first wash cycle

After the appliance has been installed, immediately before running the first wash cycle, completely fill the salt dispenser with water and add only then approximately 1 kg of salt (*see chapter entitled Rinse aid and refined salt*). The water may overflow: this is normal and is not a cause for concern. Select the water hardness value (*see chapter entitled Rinse aid and refined salt*). - After the salt has been poured into the machine, the LOW SALT indicator light* switches off.

 If the salt container is not filled, the water softener and the heating element may be damaged as a result.

Technical data	
Dimensions	width 60 cm height 85 cm depth 60 cm
Capacity	14 standard place-settings
Water supply pressure	0,05 ÷ 1MPa (0.5 ÷ 10 bar) 7,25 – 145 psi
Power supply voltage	See appliance data plate
Total absorbed power	See appliance data plate
Fuse	See appliance data plate
 	This dishwasher conforms to the following European Community Directives: -2006/95/EC (Low Voltage) -2004/108/EC (Electromagnetic Compatibility) -2005/32/EC (Comm. Reg. 1275/2008) (Ecodesign) -97/17/EC (Labelling) -2002/96/EC Waste Electrical and Electronic Equipment (WEEE)

* Only available in selected models.

Electrical Connection

EN

Electrical Connection

If your appliance is supplied with a 13 amp. fused plug it can be plugged into a 13 amp socket for immediate use. Before using the appliance please read the instruction below.

⚠ WARNING: THIS APPLIANCE MUST BE EARTHED. THE FOLLOWING OPERATIONS SHOULD BE CARRIED OUT BY A QUALIFIED ELECTRICIAN.

Replacing the fuse:

When replacing a faulty fuse, a 13 amp ASTA approved fuse to BS 1362 should always be used, and the fuse cover re-fitted. If the fuse cover is lost, the plug must not be used until a replacement is obtained.

Replacement fuse covers:

If a replacement fuse cover is fitted, it must be of the correct colours as indicated by the coloured marking or the colour that is embossed in words on the base of the plug. Replacements can be obtained directly from your nearest Service Depot.

Removing the plug:

If your appliance has a non-rewireable moulded plug and you should wish to remove it to re-route the mains cable through partitions, units etc., please ensure that either:

- the plug is replaced by a fused 13 amp re-wireable plug bearing the BSI mark of approval
- or:
- the mains cable is wired directly into a 13 amp cable outlet, controlled by a switch, (in compliance with BS 5733) which is accessible without moving the appliance.

Disposing of the plug:

Ensure that before disposing of the plug itself, you make the pins unusable so that it cannot be accidentally inserted into a socket.

Instruction for connecting cable to an alternative plug:

Important: the wires in the mains lead are coloured in accordance with the following code:

Green & Yellow - **Earth**
Blue - **Neutral**
Brown - **Live**

⚠ CAUTION:

- Once the appliance has been installed, the electrical plug and socket should remain accessible.
- The Company shall not be held responsible for any incidents that occur if these regulations are not observed.

As the colours of the wires in the mains lead may not correspond with the coloured markings identifying the terminal in your plug, proceed as follows:
connect Green & Yellow wire to terminal marked “E” or coloured Green or Green & Yellow.
Connect Brown wire to terminal marked “L” or coloured Red.
Connect Blue wire to terminal marked “N” or coloured Black.

If a 13 amp plug (BS 1363) is used it must be fitted with a 13 amp fuse. A 15 amp plug must be protected by a 15 amp fuse, either in the plug or adaptor or at the distribution board.

If you are in any doubt about the electrical supply to your machine, consult a qualified electrician before use.

How to connect an alternative plug:

The wires in this mains lead are coloured in accordance with the following code:

BLUE “NEUTRAL” (“N”)
BROWN “LIVE” (“L”)
GREEN AND YELLOW “EARTH” (“E”) or \perp

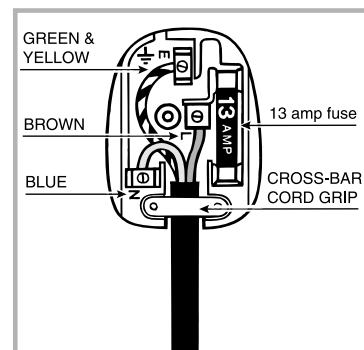

Disposing of the appliance:

When disposing of the appliance please remove the plug by cutting the mains cable as close as possible to the plug body and dispose of it as described above.

Description of the appliance

Overall view

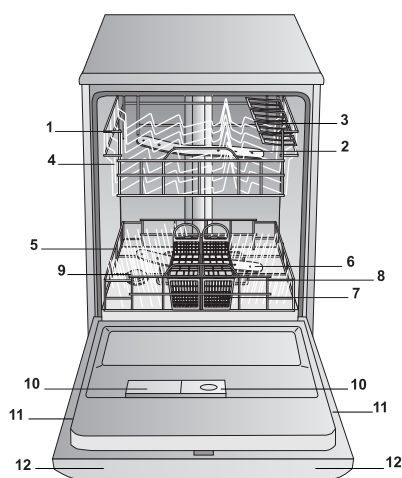

1. Upper rack
2. Upper sprayer arm
3. Tip-up compartments
4. Rack height adjuster
5. Lower rack
6. Lower sprayer arm
7. Cutlery basket
8. Washing filter
9. Salt dispenser
10. Detergent and rinse aid dispensers
11. Data plate
12. Control Panel***

Control panel

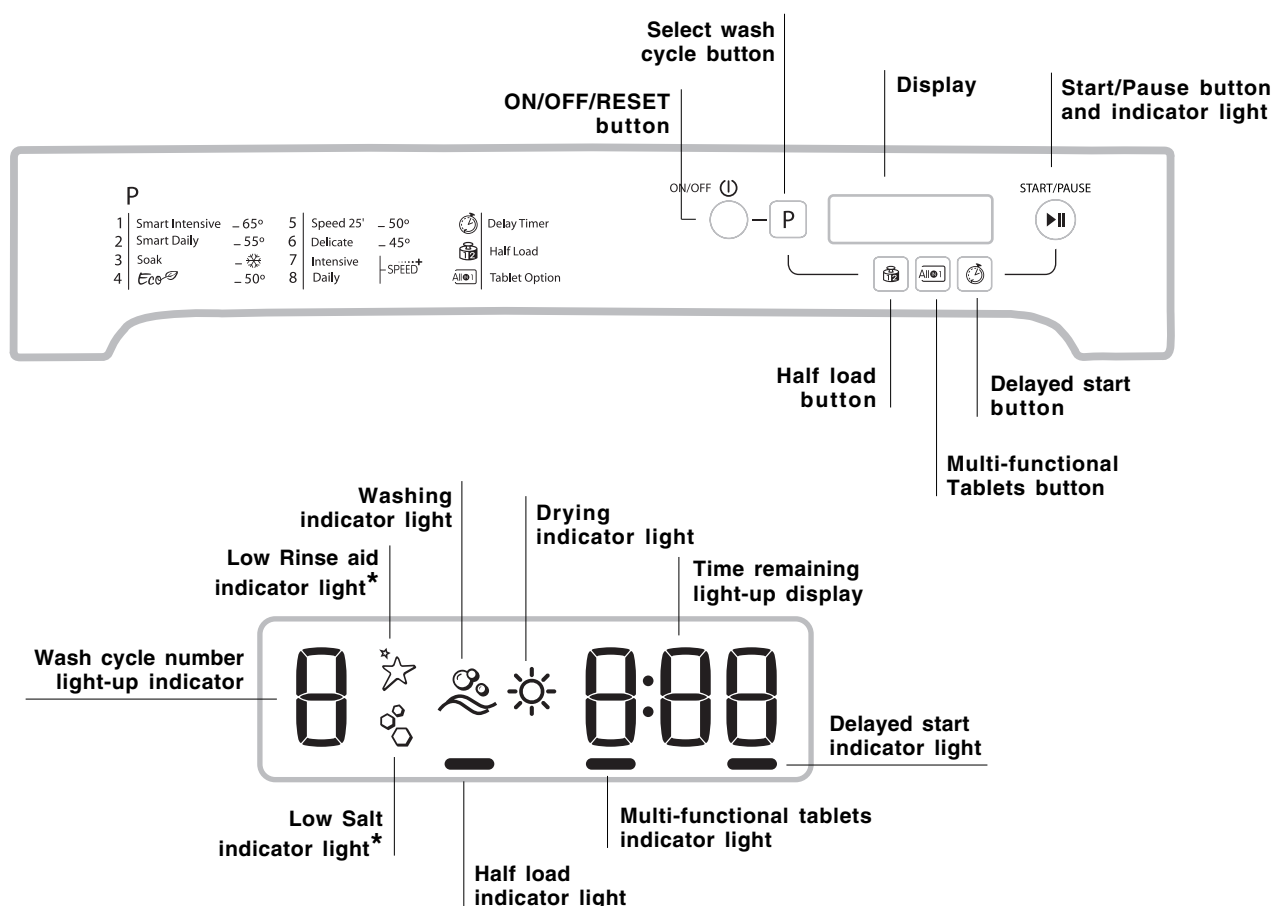

*** Only in completely built-in models.

* Only available in selected models.

The number and type of wash cycles and options may vary depending on the dishwasher model.

Loading the racks

EN

 Before loading the racks, remove all food residues from the crockery and empty liquids from glasses and cups.

After loading the appliance, check that the sprayer arms can rotate freely.

Lower rack

The lower rack can hold pans, lids, plates, salad bowls, cutlery, etc. as seen in the *Loading examples*.

Plates and large covers should be placed at the sides of the rack, ensuring that they do not block the rotation of the upper sprayer arm.

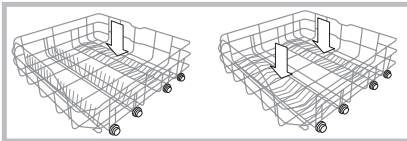

Some dishwasher models are fitted with tip-up sections*, which can be used in a

vertical position when arranging plates or in a horizontal position when arranging pans and salad bowls.

Cutlery basket

The type of cutlery basket may vary according to the dishwasher model: it may be modular, non-modular or a sliding version. The non-modular basket must **only** be positioned at the front of the lower rack.

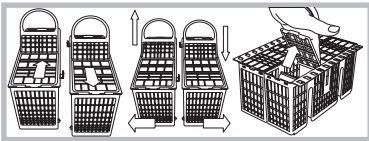

The modular basket may be separated into two parts, a solution which is recommended when performing a half

load wash (only in models offering this option), is available in a sliding version (positioned at any point on the lower rack by sliding it between the fixed or tip-up inserts).

- Both versions are fitted with a collapsible sliding system which means the cutlery can be arranged in the best possible way.

 Knives and other utensils with sharp edges must be placed in the cutlery basket with the points facing downwards, or they must be positioned horizontally in the tip-up compartments on the upper rack.

Cutlery basket positioning examples

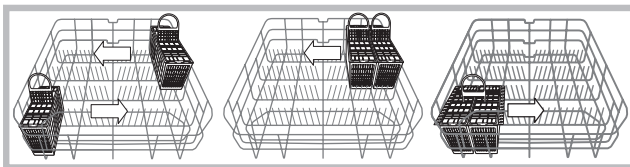

Upper rack

Load this rack with delicate and lightweight crockery: glasses, tea and coffee cups, saucers, small salad bowls, saucepans and small saucepans which are not too soiled, using the *Loading examples* as a guide.

• Mugs and cups, long sharp knives and serving utensils: place these on the tip-up compartments**.

Tip-up compartments with adjustable tilt

- The tilt feature can be used to increase the space in the upper rack, to position wine glasses with different stem lengths safely and to improve drying performance.

Tilt A

Tilt B

Tilt C

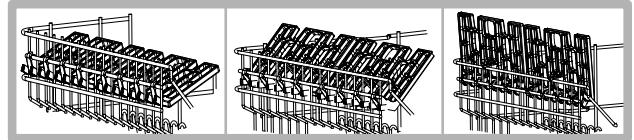

- Lift the tip-up compartment, slide it gently and position it in the desired tilt angle.

Adjusting the height of the upper rack

In order to make it easier to arrange the crockery, the upper rack may be moved to a higher or lower level.

 **The height of the upper rack should ideally be adjusted WHEN THE RACK IS EMPTY.**

Never lift or lower the rack on one side only.

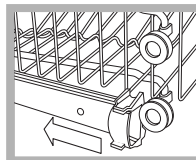

Open the left and right guide rail stops and pull out the rack; position it higher or lower as required, slide it along the guide rails until the front wheels are in place and close the stops (*see figure*).

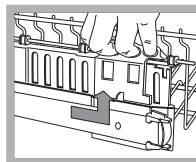

If the rack is fitted with "Dual Space" handles* (*see figure*), pull out the upper rack until it reaches its stop point, grip the handles at the sides of the rack and move it upwards or downwards, then slowly let it fall back into place.

Loading examples for the upper/lower rack

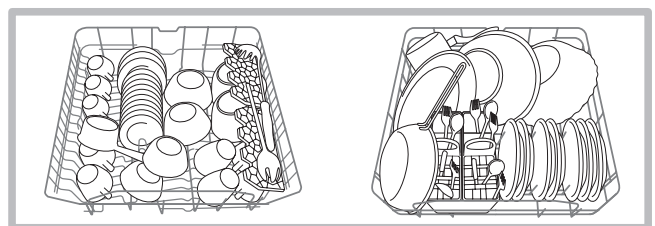

Items which should not be washed in the dishwasher

- Wooden items, objects with wooden or horn handles or glued-on parts.
- Items made from aluminium, copper, brass, pewter or tin.
- Items made from plastic material which is not heat-resistant.
- Antique or hand-painted porcelain.
- Antique silver. Silver which is not antique may, however, be washed in the dishwasher using a delicate wash cycle, provided that it does not come into contact with other metals.

 We recommend the use of crockery which is dishwasher safe.

* Only available in selected models.

** The number and position may vary.

Starting the dishwasher

1. Turn the water tap on.
2. Press the ON/OFF button: all the indicator lights on the control panel will light up for a few seconds.
3. Open the door and pour in a suitable amount of detergent (*see below*).
4. Load the racks (*see Loading the racks*) and shut the door.
5. Select the wash cycle in accordance with the type of crockery and its soil level (*see Table of wash cycles*) by pressing the P button.
6. Select the wash options* (*see adjacent information*).
7. Start the cycle by pressing the Start/Pause button (fixed light). A long beep signals the start of the wash cycle; the wash cycle indicator light is illuminated and the time remaining until the end of the cycle is displayed.
8. Two short beeps and one long one indicate the end of the wash cycle; the Start/Pause button switches off and the word **END** appears on the display. Switch off the appliance by pressing the ON/OFF button, shut off the water valve and unplug the appliance from the electricity socket.
9. Wait for a few minutes before removing the crockery, in order to avoid burns. Unload the racks, beginning with the lower level.

 - **The machine will switch off automatically during certain periods of inactivity, in order to minimise electricity consumption.**

Modifying a wash cycle in progress

If a mistake was made during the wash cycle selection process it is possible to change the cycle, provided that it has only just begun: once the wash cycle has started, switch off the machine by pressing and holding the ON/OFF/Reset button. Switch it back on using the same button and select the desired wash cycle and options.

Adding extra crockery

Press the Start/Pause button (the corresponding indicator light will flash). Open the door, taking care to avoid the escaping steam, and place the crockery inside the appliance. Press the Start/Pause button (fixed light): the cycle starts from the point at which it was interrupted.

 If the Start/Pause button is pressed so as to pause the machine, the wash cycle or the Delayed Start* function (if selected) is interrupted.
At this stage it is not possible to change the wash cycle.

Accidental interruptions

If the door is opened during the wash cycle, or if there is a power cut, the cycle stops. It starts again from the point at which it was interrupted once the door has been shut or once the electricity supply is restored.

Measuring out the detergent

A good wash result also depends on the correct amount of detergent being used; exceeding the stated amount does not result in a more effective wash and increases environmental pollution.

 **Only use detergent which has been specifically designed for dishwashers.**

 **DO NOT USE** washing up liquid.

 **Using excessive detergent may result in foam residue remaining in the machine after the cycle has ended.**

 **The use of tablets is only recommended for models which offer the MULTI-FUNCTIONAL TABLETS option.**

 **To achieve the best results from each washing and drying cycle, powder detergent, rinse aid liquid and salt should be used.**

Compartment A: Washing detergent

Compartment B: Pre-wash detergent

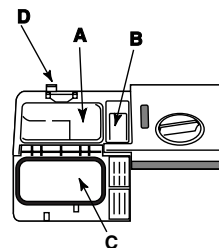

1. Open cover C by pressing button D.

2. Pour in the detergent after consulting the *Table of wash cycles*:

- For powder detergent use compartments A and B.
- For detergent in tablet form:

when the cycle requires 1 tablet, place it in compartment A and close the cover; when it requires 2, place the second tablet at the bottom of the appliance.
3. Remove detergent residues from the edges of the compartment and close the cover until it clicks.

* Only available in selected models.

Wash options

The **OPTIONS** may only be set, modified or reset after the wash cycle has been selected and before the Start/Pause button has been pressed.

Only the options which are compatible with the type of wash cycle set may be selected. If an option is not compatible with the selected was cycle (*see Table of wash cycles*), the corresponding LED flashes rapidly 3 times.

If an option is selected which is incompatible with another option or wash cycle selected previously, the incompatible option light will flash 3 times and switches off, while the most recently selected setting remains lit.

 To deselect an option which has been set by mistake, press the corresponding button again.

Delayed start

The start of the wash cycle may be delayed for a period of time between **1** and **24** hours.

1. After selecting the desired wash cycle and any other options, press the DELAYED START button: the corresponding indicator light will illuminate. Use the same button to select the time at which you wish the wash cycle to begin (after a period of 1 to 24 hours).
2. Confirm your selection using the Start/Pause button; the countdown will begin. The selected delay period indicator light is displayed and the Start/Pause button stops flashing (the light becomes fixed instead).
3. When the set time has elapsed, a long beep sounds, the DELAYED START indicator light switches off and the wash cycle begins.

To deselect the DLEAYED START option, press the DELAYED START button repeatedly until the text **OFF** appears.

 **The Delayed Start function cannot be set once the wash has been started.**

Half load

If there are not many dishes to be washed, a half load cycle may be used in order to save water, electricity and detergent. Select the wash cycle and press the HALF LOAD button: the indicator light will illuminate.

 **Remember to halve the amount of detergent.**

 **It is better to use powder detergent in this case.**

 **This option is incompatible with the following wash cycle: Speed wash, Intensive Speed+ and Daily Speed+.**

Multi-functional tablets (Tabs)

This option optimises washing and drying results. When using multi-functional tablets, press the MULTI-FUNCTIONAL TABLETS button. The corresponding indicator light will illuminate. The "Multi-functional tablets" option results in the lengthening of the wash cycle.

 **The MULTI-FUNCTIONAL TABLETS option remains set for subsequent wash cycles if it is not deselected.**

 **The use of tablets is only recommended for models which offer the MULTI-FUNCTIONAL TABLETS option.**

 **This option is not recommended for use with wash cycles which do not specify the use of multi-functional tablets (*see Table of options*).**

 **This option is incompatible with the following wash cycle: Soak.**

Table of options	A	B	C
	Delayed Start	Half Load	Tabs
1. Smart Intensive	Yes	Yes	Yes
2. Smart Daily	Yes	Yes	Yes
3. Soak	Yes	Yes	No
4. Eco	Yes	Yes	Yes
5. Speed 25'	Yes	No	Yes
6. Delicate	Yes	Yes	Yes
7. Intensive Speed+	Yes	No	Yes
8. Daily Speed+	Yes	No	Yes

* Only available in selected models.

Wash cycles

 If the crockery is only lightly soiled or if it has been rinsed with water before being placed in the dishwasher, reduce the amount of detergent used accordingly.

 The number and type of wash cycles and options may vary depending on the dishwasher model.

 For available OPTIONS please refer to the Table of options on the Start-up and use page.

Wash cycle selection instructions	Wash cycle	Detergent (A) = compartment A (B) = compartment B			Wash cycles which include drying	Options	Wash cycle duration (tolerance $\pm 10\%$) Hrs. Min.
		Powder	Liquid	Tablets			
Heavily soiled dishes and pans (not to be used for delicate items).	1. Smart Intensive	35 g (A)	35 ml (A)	1 (A)	Yes	A-B-C	2:25'
Normally soiled pans and dishes. Standard daily wash cycle.	2. Smart Daily	29 g (A) 6 g (B)	29 ml (A) 6 ml (B)	1 (A)	Yes	A-B-C	1:50'
Pre-wash for dishes while awaiting completion of the load with the dishes from the next meal.	3. Soak	No	No	No	No	A-B	0:08'
Environmentally-friendly wash cycle with low energy consumption levels, suitable for pans and dishes.	4. Eco*	29 g (A) 6 g (B)	29 ml (A) 6 ml (B)	1 (A)	Yes	A-B-C	2:35'
Economic and fast wash to be used for lightly soiled dishes. (Run cycle immediately after use) (2 plates + 2 glasses + 4 pieces of cutlery + 1 saucepan + 1 small frying pan).	5. Speed 25'	25 g (A)	25 ml (A)	1 (A)	No	A-C	0:25'
Economic and fast wash for delicate items which are sensitive to high temperatures. (Run cycle immediately after use) (glasses upper rack + delicate plates lower rack).	6. Delicate	35 g (A)	35 g (A)	1 (A)	Yes	A-B-C	1:30'
Quick wash and dry cycle, suitable for heavily soiled crockery and pans (not suitable for delicate items).	7. Intensive Speed+	35 g (A)	35 ml (A)	1 (A)	Yes	A-C	1:40'
Quick wash and dry cycle, suitable for crockery and pans with a normal soil level.	8. Daily Speed+	29 g (A) 6 g (B)	29 ml (A) 6 ml (B)	1 (A)	Yes	A-C	1:20'

Notes:

Optimum performance levels when using the "Speed wash" cycles can be achieved by observing the maximum amounts of crockery specified.

To make it easier to measure out the detergent, it is worth remembering that:

1 tablespoon = 15 gr. of powder = approximately 15 ml of liquid - 1 teaspoon = 5 gr. of powder = approximately 5 ml of liquid

* The Eco wash cycle adheres to the regulation EN-50242. Although it has a longer duration than other wash cycles it uses less energy and is less harmful to the environment.

Note for Test Laboratories: for information relating to comparative EN testing conditions, please send an email to the following address: ASSISTENZA_EN_LVS@indesitcompany.com

Rinse aid and refined salt

EN

⚠ Only use products which have been specifically designed for dishwashers. Do not use table salt or industrial salt, or washing up liquid. Follow the instructions given on the packaging.

⚠ If using a multi-functional product it is not necessary to add rinse aid; however, we recommend that you add salt, especially if you live in an area where the water is hard or very hard. Follow the instructions given on the packaging.

⚠ If you do not add salt or rinse aid, the LOW SALT* and LOW RINSE AID* indicator lights remain lit.

Measuring out the rinse aid

Rinse aid makes it easier for the crockery to dry, as water runs off surfaces more readily and therefore does not leave streaks or marks.

The rinse aid dispenser should be filled:

- When the LOW RINSE AID* indicator light on the control panel/display is illuminated;

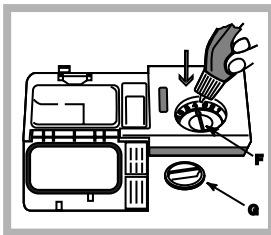

1. Open the dispenser by turning the lid (G) in an anticlockwise direction.
2. Pour in the rinse aid, making sure it does not overflow from the dispenser. If this happens, clean the spill immediately with a dry cloth.
3. Screw the lid back on.

NEVER pour the rinse aid directly into the appliance tub.

Adjusting the amount of rinse aid

If you are not completely satisfied with the drying results, you may adjust the quantity of rinse aid used. Use a screwdriver to turn the dosage adjuster (F) to one of the 6 pre-set positions (the default position is set to 4):

- If there are streaks on the crockery, set the adjustment device to a lower number (1-3).
- If drops of water remain on the crockery or if there are limescale marks present after the cycle has finished, set the adjuster to a higher number (4-6).

Setting the water hardness

Every dishwasher is equipped with a water softener which, by using refined salt designed especially for this type of appliance, supplies water without limescale which is then used to wash the crockery.

This dishwasher offers a setting which helps to reduce pollution and optimises washing performance in accordance with the water hardness level in your area. This information can be obtained from your local water supplier.

- Switch on the appliance by pressing the **ON/OFF** button.
- Press the **P** button and hold for approximately 5 seconds; two short beeps will sound, the text **H2O** will appear on the display and the set hardness number will flash (the water softening system is set by default to number 3). Press the **P**

button repeatedly until the desired hardness level has been reached (1-2-3-4-5* see *Water hardness table*), up to a maximum of five levels.

- To exit the function, wait approximately few seconds or press another option* button, or switch off the machine using the **ON/OFF** button.

Even if using multi-functional tablets, the salt dispenser should still be filled.

Water Hardness Table						
°dH		°fH		mmol/l		level
0	6	0	10	0	1	1
6	11	11	20	1.1	2	2
12	17	21	30	2.1	3	3
17	34	31	60	3.1	6	4
34	50	61	90	6.1	9	5*

For values between 0°f and 10°f, we do not recommend the use of salt.
* this setting may cause a slight increase in the duration of the cycle.

(°dH = hardness measured in German degrees - °f = hardness measured in French degrees - mmol/l = millimoles per litre)

Measuring out the refined salt

In order to achieve the best possible results using a wash cycle, make sure that the dispenser is never empty. Refined salt removes limescale from the water, thus avoiding the formation of deposits on crockery. The salt dispenser is located in the lower part of the dishwasher (*see Description*) and should be filled:

- When the green float* cannot be seen by simply looking at the cap of the salt dispenser.
- When the LOW SALT* indicator light on the control panel/display is illuminated;

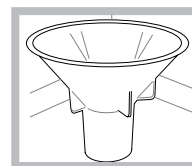

1. Remove the lower rack and unscrew the container cap (anticlockwise).
2. The first time you do this: fill the water tank right up to its edge.
3. Position the funnel* (*see figure*) and fill the salt container right up to its edge

(this should hold approximately 1 kg); it is not unusual for a little water to leak out.

4. Remove the funnel* and wipe any salt residue away from the opening; rinse the cap under running water and then screw it on, the head facing downwards so as to let the water flow out of the four cracks which are arranged in a star shape on the lower part of the cap. (Salt cap with green float*)

It is advisable to perform this procedure every time you add salt to the container.

Make sure the cap is screwed on tightly, so that no detergent can get into the container during the wash cycle (this could damage the water softener beyond repair).

⚠ When necessary, measure out the salt before a wash cycle so that any saline solution which has leaked out of the salt dispenser is removed.

* Only available in selected models.

Shutting off the water and electricity supplies

- Turn off the water tap after every wash cycle to avoid leaks.
- Always unplug the appliance when cleaning it and when performing maintenance work.

Cleaning the dishwasher

- The external surfaces of the machine and the control panel may be cleaned using a non-abrasive cloth which has been dampened with water. Do not use solvents or abrasive products.
- Any marks on the inside of the appliance may be removed using a cloth dampened with water and a little vinegar.

Preventing unpleasant odours

- Always keep the door of the appliance ajar in order to avoid moisture from forming and being trapped inside the machine.
- Clean the seals around the door and detergent dispensers regularly using a damp sponge. This will avoid food becoming trapped in the seals, which is the main cause behind the formation of unpleasant odours.

Cleaning the sprayer arms

Food residue may become encrusted onto the sprayer arms and block the holes used to spray the water. It is therefore recommended that the arms are checked from time to time and cleaned with a small non-metallic brush.

The two sprayer arms may both be removed.

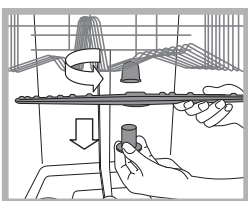

To remove the upper sprayer arm, rotate the locking ring in an anti-clockwise direction. The upper sprayer arm should be replaced with the holes facing upwards.

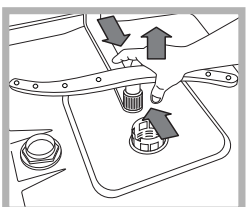

The lower sprayer arm can be removed by pressing on the side tabs and pulling it upwards.

Cleaning the water inlet filter*

If the water hoses are new or have not been used for an extended period of time, let the water run to make sure it is clear and free of impurities before performing the necessary connections. If this precaution is not taken, the water inlet could become blocked and damage the dishwasher.

- ⚠ Clean the water inlet filter at the tap outlet regularly.
 - Turn off the water tap.
 - Unscrew the end of the water inlet hose, remove the filter and clean it carefully under running water.
 - Replace the filter and screw the water hose back into position.

Cleaning the filters

The filter assembly consists of three filters which remove food residues from the washing water and then recirculate the water. They should be cleaned if you wish to achieve the best results in every wash.

- ⚠ Clean the filters regularly.
- ⚠ The dishwasher should not be used without filters, or if the filter is loose.
 - After several washes, check the filter assembly and if necessary clean it thoroughly under running water, using a non-metallic brush and following the instructions below:
 1. Turn the cylindrical filter C in an anti-clockwise direction and pull it out (fig. 1).
 2. Remove the cup filter B by exerting a slight pressure on the side flaps (fig. 2).
 3. Slide out the stainless steel plate filter A (fig. 3).
 4. Inspect the trap and remove any food residue. **NEVER REMOVE** the wash cycle pump (black detail) (fig. 4).

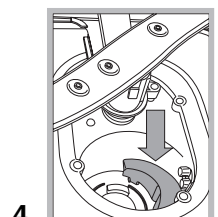
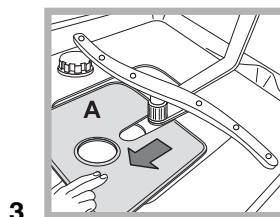
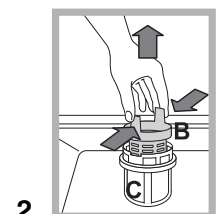
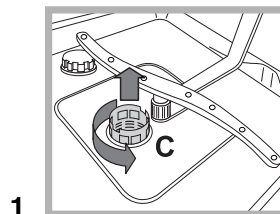

After cleaning the filters, replace the filter assembly and fix it in position correctly; this is essential for maintaining the efficient operation of the dishwasher.

Leaving the machine unused for extended periods

- Disconnect the appliance from the electricity supply and shut off the water tap.
- Leave the door of the appliance ajar.
- When you return, run a wash cycle when the dishwasher is empty.

Precautions and advice

EN

 This appliance was designed and manufactured in compliance with current international safety standards. The following information has been provided for safety reasons and should therefore be read carefully.

General safety

- This appliance is not intended for use by persons (including children) with reduced physical, sensory or mental capabilities, or lack of experience and knowledge, unless they have been given supervision or instruction concerning use of the appliance by a person responsible for their safety.
- Children should be supervised to ensure that they do not play with the appliance.
- The appliance was designed for domestic use inside the home and is not intended for commercial or industrial use.
- The appliance must be used by adults only, to wash domestic crockery in accordance with the instructions in this manual.
- The appliance must not be installed outdoors, even in covered areas. It is extremely dangerous to leave the machine exposed to rain and storms.
- Do not touch the appliance when barefoot.
- When unplugging the appliance always pull the plug from the mains socket, do not pull on the cable.
- The water supply tap must be shut off and the plug should be removed from the electrical socket before cleaning the appliance or carrying out any maintenance work.
- If the appliance breaks down, do not under any circumstances touch the internal parts in an attempt to perform the repair work yourself.
- Never touch the heating element.
- Do not lean or sit on the open door of the appliance: this may cause the appliance to overturn.
- The door should not be left open as it may create a dangerous obstacle.
- Keep detergent and rinse aid out of reach of children.
- The packaging material should not be used as a toy.

Disposal

- Disposal of packaging materials: observe local legislation so that the packaging may be reused.
- The European Directive 2002/96/EC relating to Waste Electrical and Electronic Equipment (WEEE) states that household appliances should not be disposed of using the normal solid urban waste cycle. Exhausted appliances should be collected separately in order to optimise the cost of re-using and recycling the materials inside the machine, while preventing potential damage to the atmosphere and to public health. The crossed-out dustbin is marked on all products to remind the owner of their obligations regarding separated waste collection.

For further information relating to the correct disposal of household appliances, owners may contact the relevant public authority or the local appliance dealer.

Saving energy and respecting the environment

Saving water and energy

- Only begin a wash cycle when the dishwasher is full. While waiting for the dishwasher to be filled, prevent unpleasant odours using the Soak cycle (*see Wash cycles*).
- Select a wash cycle which is suited to the type of crockery and to the soil level of the crockery using the *Table of wash cycles*:
 - For dishes with a normal soil level, use the Eco wash cycle, which guarantees low energy and water consumption levels.
 - If the load is smaller than usual activate the Half load option* (*see Start-up and use*).
- If your electricity supply contract gives details of electricity saving time bands, run wash cycles during the periods when a lower tariff is applied. The Delayed start* button (*see Start-up and use*) helps you organise the wash cycles accordingly.

Phosphate-free and chlorine-free detergents containing enzymes

- We strongly recommend that you use detergents that do not contain phosphates or chlorine, as these products are harmful to the environment.
- Enzymes provide a particularly effective action at temperatures around 50°C, and as a result detergents containing enzymes can be used in conjunction with low-temperature wash cycles in order to achieve the same results as a normal 65°C wash cycle.
- To avoid wasting detergent, use the product in appropriate quantities based on the manufacturer's recommendations, the hardness of the water and the soil level and quantity of crockery to be washed. Even if they are biodegradable, detergents contain substances which may alter the balance of nature.

* Only available in selected models.

Whenever the appliance fails to work, check for a solution from the following list before calling for Assistance.

Problem:	Possible causes / Solutions:
The dishwasher does not start or cannot be controlled	<ul style="list-style-type: none"> • Switch off the appliance by pressing the ON/OFF button, switch it back on after approximately one minute and reset the program. • The appliance has not been plugged in properly. • The dishwasher door has not been shut properly.
The door won't close	<ul style="list-style-type: none"> • The lock was released. Strongly push the door until a "clacking" noise is heard.
No water drains out from the dishwasher.	<ul style="list-style-type: none"> • The dishwasher cycle has not yet finished. • The water inlet hose is bent (see Installation). • The drain duct is blocked. • The filter is clogged up with food residues.
The dishwasher makes excessive noise.	<ul style="list-style-type: none"> • The dishes are rattling against each other or against the sprayer arms. • An excessive amount of foam has been produced: the detergent has not been measured out correctly or it is not suitable for use in dishwashers (see Start-up and use).
The dishes and glasses are covered in a white film or limescale deposits.	<ul style="list-style-type: none"> • The level of the refined salt is low or the dosage setting is not suited to the hardness of the water (see Rinse aid and salt). • The lid on the salt dispenser is not closed properly. • The rinse aid has been used up or the dosage is too low.
The dishes and glasses are streaked or have a bluish tinge.	<ul style="list-style-type: none"> • The rinse aid dosage is too high.
The crockery has not been dried properly.	<ul style="list-style-type: none"> • A wash cycle without a drying program has been selected. • The rinse aid has been used up or the dosage is too low (see Rinse aid and salt). • The rinse aid dispenser setting is not suitable. • The crockery is made from non-stick material or plastic.
The dishes are not clean.	<ul style="list-style-type: none"> • The racks are overloaded (see Loading the racks). • The crockery has not been arranged well. • The sprayer arms cannot move freely. • The wash cycle is too gentle (see Wash cycles). • An excessive amount of foam has been produced: the detergent has not been measured out correctly or it is not suitable for use in dishwashers (see Start-up and use). • The lid on the rinse aid compartment has not been shut correctly. • The filter is dirty or blocked (see Care and maintenance). • The refined salt level is low (see Rinse aid and salt).
The dishwasher does not take any water in - Tap shut-off alarm (the display shows A 6).	<ul style="list-style-type: none"> • There is no water in the mains supply. • The water inlet hose is bent (see Installation). • Turn on the tap and the appliance will start after a few minutes. • The appliance lock has been activated because no action was taken when the beeps* sounded. <p>Switch off the appliance using the ON/OFF button, turn on the tap and switch the appliance back on after 20 seconds by pressing the same button. Re-program the appliance and restart the wash cycle.</p>
Water inlet hose alarm / Water inlet filter blocked (the display shows A 7).	<ul style="list-style-type: none"> • Switch off the appliance by pressing the ON/OFF button. Shut off the water tap to eliminate the risk of flooding and remove the plug from the electrical socket. Make sure the water inlet filter has not become blocked by impurities (see "Care and maintenance" chapter).

* Only available in selected models.

Guarantee

12 months Parts and Labour Guarantee

Your appliance has the benefit of our manufacturer's guarantee, which covers the cost of breakdown repairs for twelve months from the date of purchase.

This gives you the reassurance that if, within that time, your appliance is proven to be defective because of either workmanship or materials, we will, at our discretion, either repair or replace the appliance at no cost to you.

This guarantee is subject to the following conditions:

- The appliance has been installed and operated correctly and in accordance with our operating and maintenance instructions.
- The appliance is used only on the electricity or gas supply printed on the rating plate.
- The appliance has been used for normal domestic purposes only.
- The appliance has not been altered, serviced, maintained, dismantled, or otherwise interfered with by any person not authorised by us.
- Any repair work must be undertaken by us or our appointed agent.
- Any parts removed during repair work or any appliance that is replaced become our property.
- The appliance is used in the United Kingdom or Republic of Ireland.

The guarantee does not cover:

- Damage resulting from transportation, improper use, neglect or interference or as a result of improper installation.
- Replacement of any consumable item or accessory. These included but not limited to: plugs, cables, batteries, light bulbs, fluorescent tubes and starters, covers and filters.
- Replacement of any removable parts made of glass or plastic.

THIS GUARANTEE WILL NOT APPLY IF THE APPLIANCE HAS BEEN USED IN COMMERCIAL OR NON-DOMESTIC PREMISES.

5 Year Parts Guarantee

Indesit also offers you a free 5 year parts guarantee. This additional guarantee is conditional on you registering your appliance with us and the parts being fitted by one of our authorised engineers. There will be a charge for our engineer's time. To activate the extra parts warranty on your appliance, simply call our registration line on **08448 24 24 24 (Republic of Ireland 01 230 0800)**

Extended Guarantees

We offer a selection of protection plans that enable you to fully cover yourself against the expense of repair bills for the life of your policy. To find the ideal plan for you please call our advice line on **08448 226 226 (Republic of Ireland 01 230 0233)**.

Free Helpdesk Service

We have a dedicated team who can provide free advice and assistance with your appliance if you experience any technical difficulties within the first 90 days of ownership. Simply call our Indesit Service Hotline on **08448 224 224 (Republic of Ireland 0818 313 413)** for telephone assistance, or, where necessary, to arrange for an engineer to call.

After Sales Service

No one is better placed to care for your Indesit appliance during the course of its working life than us – the manufacturer.

Essential Contact Information

Indesit Service

We are the largest service team in the UK and Ireland offering you access to 400 skilled telephone advisors and 1000 fully qualified engineers on call to ensure you receive fast, reliable, local service.

UK: 08448 224 224
Republic of Ireland: 0818 313 413
www.indesitservice.co.uk

Please note: Our advisors will require the following information:

Model number:

Serial number:

Parts and Accessories

We supply a full range of genuine replacement parts as well as accessory products that protect and hygienically clean your appliance to keep it looking good and functioning efficiently throughout its life.

UK: 08448 225 225
Republic of Ireland: 0818 313 413
www.indesitservice.co.uk

Appliance Registration

We want to give you additional benefits of Indesit ownership. To activate your free 5 year parts guarantee you must register your appliance with us.

UK: 08448 24 24 24
Republic of Ireland: 01 230 0800
www.indesitservice.co.uk

Indesit Company UK Ltd. Morley Way, Peterborough, PE2 9JB
Indesit Company Unit 49 Airways Industrial Estate, Dublin 17

Recycling and Disposal Information

As part of Indesit's continued commitment to helping the environment, Indesit reserves the right to use quality, recycled components to keep down customer costs and minimise material wastage.

Please dispose of packaging and old appliances carefully. To minimise the risk of injury to children, remove the door, plug, and cut the mains cable off flush with the appliance. Dispose of these parts separately to ensure that the appliance can no longer be plugged into mains socket, and the door cannot be locked shut.

